



# TAPER BUSHES BRAND RCB<sup>®</sup>

<b>SERIES 1008 - 1108 - 1210</b>	page 4
<b>SERIES 1215 - 1610 - 1615</b>	5
<b>SERIES 2012 - 2517</b>	6
<b>SERIES 3020 - 3030</b>	7
<b>SERIES 3525 - 3535</b>	8
<b>SERIES 4030 - 4040 - 4535</b>	9
<b>SERIES 4545 - 5040 - 5050</b>	10
<b>ADAPTORS FOR TAPER BUSHES</b>	11



# TAPER BUSHES BRAND RCB®

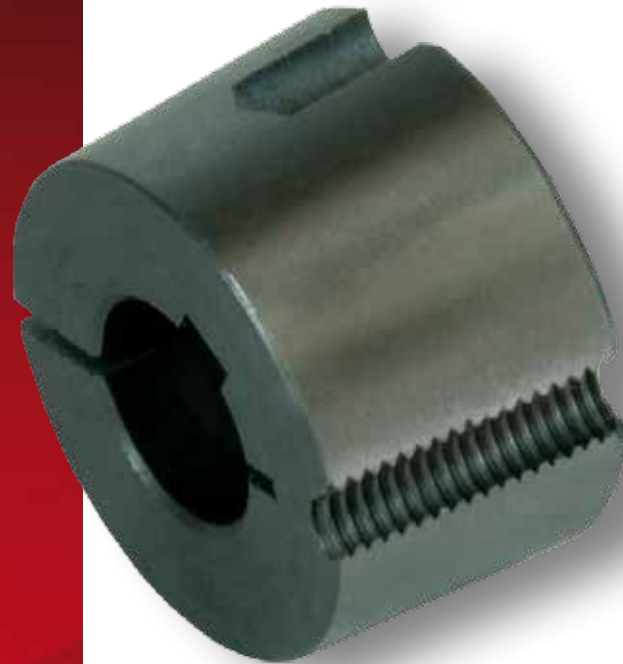



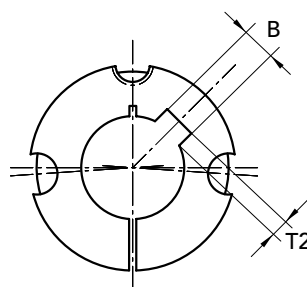

**METRIC SERIES**

 Reamings in mm. **ISO G7**

 Keyway in compliance with **DIN 6885-JS9**

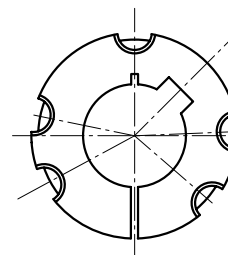
EXECUTION A



EXECUTION B

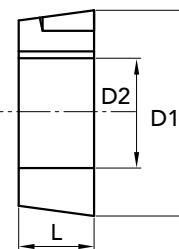

BUSHES TYPE	Ø D1	PART NUMBER	execution	L	Ø D2 H8 only prebore	Ø D2 with bore ISO G7 keyway DIN 6885-JS9	B keyway width	T2 keyway depth	GRUBSCREW British Standard Whitworth	tightening torque N/m	weight Kg
1008	35	29100800	A	22	8	-	-	-	1/4"x1/2"	5,6	0,13
1008	35	29100808	A	22	-	8	2	1,0	1/4"x1/2"	5,6	0,13
1008	35	29100810	A	22	-	10	3	1,4	1/4"x1/2"	5,6	0,13
1008	35	29100812	A	22	-	12	4	1,8	1/4"x1/2"	5,6	0,12
1008	35	29100814	A	22	-	14	5	2,3	1/4"x1/2"	5,6	0,12
1008	35	29100816	A	22	-	16	5	2,3	1/4"x1/2"	5,6	0,11
1008	35	29100818	A	22	-	18	6	2,8	1/4"x1/2"	5,6	0,10
1008	35	29100819	A	22	-	19	6	2,8	1/4"x1/2"	5,6	0,10
1008	35	29100820	A	22	-	20	6	2,8	1/4"x1/2"	5,6	0,09
1008	35	29100822	A	22	-	22	6	2,8	1/4"x1/2"	5,6	0,08
1008	35	29100824	A	22	-	24	8	2,0	1/4"x1/2"	5,6	0,07
1008	35	29100825	A	22	-	25	8	1,3	1/4"x1/2"	5,6	0,07
1108	38	29110800	A	22	12	-	-	-	1/4"x1/2"	5,6	0,15
1108	38	29110812	A	22	-	12	4	1,8	1/4"x1/2"	5,6	0,15
1108	38	29110814	A	22	-	14	5	2,3	1/4"x1/2"	5,6	0,15
1108	38	29110816	A	22	-	16	5	2,3	1/4"x1/2"	5,6	0,14
1108	38	29110818	A	22	-	18	6	2,8	1/4"x1/2"	5,6	0,13
1108	38	29110819	A	22	-	19	6	2,8	1/4"x1/2"	5,6	0,13
1108	38	29110820	A	22	-	20	6	2,8	1/4"x1/2"	5,6	0,12
1108	38	29110824	A	22	-	24	8	3,3	1/4"x1/2"	5,6	0,10
1108	38	29110825	A	22	-	25	8	3,3	1/4"x1/2"	5,6	0,09
1108	38	29110828	A	22	-	28	8	2,0	1/4"x1/2"	5,6	0,07
1210	47,5	29121000	A	25	12	-	-	-	3/8"x5/8"	19,6	0,28
1210	47,5	29121012	A	25	-	12	4	1,8	3/8"x5/8"	19,6	0,28
1210	47,5	29121014	A	25	-	14	5	2,3	3/8"x5/8"	19,6	0,27
1210	47,5	29121016	A	25	-	16	5	2,3	3/8"x5/8"	19,6	0,26
1210	47,5	29121018	A	25	-	18	6	2,8	3/8"x5/8"	19,6	0,25
1210	47,5	29121019	A	25	-	19	6	2,8	3/8"x5/8"	19,6	0,24
1210	47,5	29121020	A	25	-	20	6	2,8	3/8"x5/8"	19,6	0,24
1210	47,5	29121024	A	25	-	24	8	3,3	3/8"x5/8"	19,6	0,21
1210	47,5	29121025	A	25	-	25	8	3,3	3/8"x5/8"	19,6	0,21
1210	47,5	29121028	A	25	-	28	8	3,3	3/8"x5/8"	19,6	0,18
1210	47,5	29121030	A	25	-	30	8	3,3	3/8"x5/8"	19,6	0,17
1210	47,5	29121032	A	25	-	32	10	3,3	3/8"x5/8"	19,6	0,15

**MATERIAL GREY CAST IRON**  
**norm UNI EN 1561**

 Bushes with prebore  
 without keyway

 CAD drawings available on our site  
[www.chiaravalli.com](http://www.chiaravalli.com)

 Quantity, availability and prices  
 on B2B Chiaravalli



**METRIC SERIES**

Reamings in mm. **ISO G7**

Keyway in compliance with **DIN 6885-JS9**

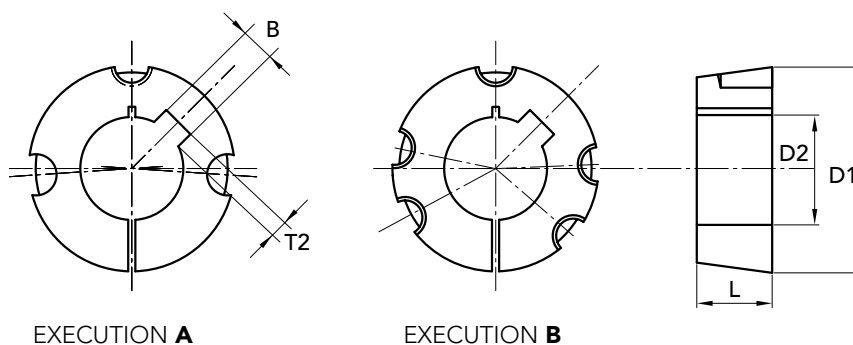

EXECUTION A

EXECUTION B

BUSHES TYPE	Ø D1	PART NUMBER	execution	L	Ø D2 H8 only prebore	Ø D2 with bore ISO G7 keyway DIN 6885-JS9	B keyway width	T2 keyway depth	GRUBSCREW British Standard Whitworth	tightening torque N/m	weight Kg
1215	47,5	29121500	A	38	12	-	-	-	3/8"x5/8"	19,6	0,38
1215	47,5	29121512	A	38	-	12	4	1,8	3/8"x5/8"	19,6	0,38
1215	47,5	29121514	A	38	-	14	5	2,3	3/8"x5/8"	19,6	0,38
1215	47,5	29121519	A	38	-	19	6	2,8	3/8"x5/8"	19,6	0,34
1215	47,5	29121520	A	38	-	20	6	2,8	3/8"x5/8"	19,6	0,34
1215	47,5	29121524	A	38	-	24	8	3,3	3/8"x5/8"	19,6	0,29
1215	47,5	29121525	A	38	-	25	8	3,3	3/8"x5/8"	19,6	0,29
1215	47,5	29121528	A	38	-	28	8	3,3	3/8"x5/8"	19,6	0,26
1610	57	29161000	A	25	12	-	-	-	3/8"x5/8"	19,6	0,41
1610	57	29161012	A	25	-	12	4	1,8	3/8"x5/8"	19,6	0,41
1610	57	29161014	A	25	-	14	5	2,3	3/8"x5/8"	19,6	0,41
1610	57	29161016	A	25	-	16	5	2,3	3/8"x5/8"	19,6	0,40
1610	57	29161018	A	25	-	18	6	2,8	3/8"x5/8"	19,6	0,39
1610	57	29161019	A	25	-	19	6	2,8	3/8"x5/8"	19,6	0,38
1610	57	29161020	A	25	-	20	6	2,8	3/8"x5/8"	19,6	0,38
1610	57	29161022	A	25	-	22	6	2,8	3/8"x5/8"	19,6	0,36
1610	57	29161024	A	25	-	24	8	3,3	3/8"x5/8"	19,6	0,36
1610	57	29161025	A	25	-	25	8	3,3	3/8"x5/8"	19,6	0,35
1610	57	29161028	A	25	-	28	8	3,3	3/8"x5/8"	19,6	0,32
1610	57	29161030	A	25	-	30	8	3,3	3/8"x5/8"	19,6	0,30
1610	57	29161032	A	25	-	32	10	3,3	3/8"x5/8"	19,6	0,29
1610	57	29161035	A	25	-	35	10	3,3	3/8"x5/8"	19,6	0,26
1610	57	29161038	A	25	-	38	10	3,3	3/8"x5/8"	19,6	0,23
1610	57	29161040	A	25	-	40	12	3,3	3/8"x5/8"	19,6	0,21
1610	57	29161042	A	25	-	42	12	2,2	3/8"x5/8"	19,6	0,19
1615	57	29161500	A	38	12	-	-	-	3/8"x5/8"	19,6	0,58
1615	57	29161512	A	38	-	12	4	1,8	3/8"x5/8"	19,6	0,58
1615	57	29161514	A	38	-	14	5	2,3	3/8"x5/8"	19,6	0,58
1615	57	29161516	A	38	-	16	5	2,3	3/8"x5/8"	19,6	0,58
1615	57	29161518	A	38	-	18	6	2,8	3/8"x5/8"	19,6	0,56
1615	57	29161519	A	38	-	19	6	2,8	3/8"x5/8"	19,6	0,55
1615	57	29161520	A	38	-	20	6	2,8	3/8"x5/8"	19,6	0,55
1615	57	29161522	A	38	-	22	6	2,8	3/8"x5/8"	19,6	0,53
1615	57	29161524	A	38	-	24	8	3,3	3/8"x5/8"	19,6	0,50
1615	57	29161525	A	38	-	25	8	3,3	3/8"x5/8"	19,6	0,49
1615	57	29161528	A	38	-	28	8	3,3	3/8"x5/8"	19,6	0,47
1615	57	29161530	A	38	-	30	8	3,3	3/8"x5/8"	19,6	0,45
1615	57	29161532	A	38	-	32	10	3,3	3/8"x5/8"	19,6	0,41
1615	57	29161535	A	38	-	35	10	3,3	3/8"x5/8"	19,6	0,38
1615	57	29161538	A	38	-	38	10	3,3	3/8"x5/8"	19,6	0,32
1615	57	29161540	A	38	-	40	12	3,3	3/8"x5/8"	19,6	0,29
1615	57	29161542	A	38	-	42	12	3,3	3/8"x5/8"	19,6	0,29

**METRIC SERIES**

 Reamings in mm. **ISO G7**

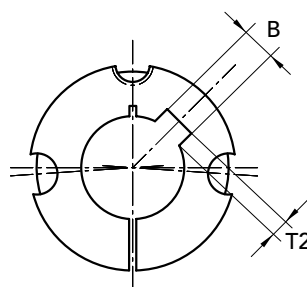
 Keyway in compliance with **DIN 6885-JS9**

EXECUTION A

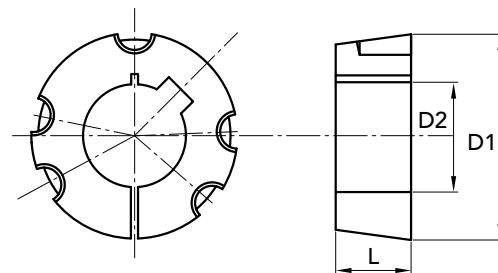

EXECUTION B

BUSHES TYPE	Ø D1	PART NUMBER	execution	L	Ø D2 H8 only prebore	Ø D2 with bore ISO G7 keyway DIN 6885-JS9	B keyway width	T2 keyway depth	GRUBSCREW British Standard Whitworth	tightening torque N/m	weight Kg
2012	70	29201200	A	32	16	-	-	-	7/16"x7/8"	30,4	0,76
2012	70	29201216	A	32	-	16	5	2,3	7/16"x7/8"	30,4	0,76
2012	70	29201218	A	32	-	18	6	2,8	7/16"x7/8"	30,4	0,76
2012	70	29201219	A	32	-	19	6	2,8	7/16"x7/8"	30,4	0,76
2012	70	29201220	A	32	-	20	6	2,8	7/16"x7/8"	30,4	0,75
2012	70	29201224	A	32	-	24	8	3,3	7/16"x7/8"	30,4	0,72
2012	70	29201225	A	32	-	25	8	3,3	7/16"x7/8"	30,4	0,71
2012	70	29201228	A	32	-	28	8	3,3	7/16"x7/8"	30,4	0,68
2012	70	29201230	A	32	-	30	8	3,3	7/16"x7/8"	30,4	0,66
2012	70	29201232	A	32	-	32	10	3,3	7/16"x7/8"	30,4	0,64
2012	70	29201235	A	32	-	35	10	3,3	7/16"x7/8"	30,4	0,60
2012	70	29201238	A	32	-	38	10	3,3	7/16"x7/8"	30,4	0,57
2012	70	29201240	A	32	-	40	12	3,3	7/16"x7/8"	30,4	0,54
2012	70	29201242	A	32	-	42	12	3,3	7/16"x7/8"	30,4	0,51
2012	70	29201245	A	32	-	45	14	3,8	7/16"x7/8"	30,4	0,46
2012	70	29201248	A	32	-	48	14	3,8	7/16"x7/8"	30,4	0,40
2012	70	29201250	A	32	-	50	14	3,8	7/16"x7/8"	30,4	0,37
2517	85,5	29251700	A	45	15	-	-	-	1/2"x1"	48	1,62
2517	85,5	29251715	A	45	-	15	5	2,3	1/2"x1"	48	1,62
2517	85,5	29251718	A	45	-	18	6	2,8	1/2"x1"	48	1,62
2517	85,5	29251719	A	45	-	19	6	2,8	1/2"x1"	48	1,62
2517	85,5	29251720	A	45	-	20	6	2,8	1/2"x1"	48	1,60
2517	85,5	29251722	A	45	-	22	6	2,8	1/2"x1"	48	1,57
2517	85,5	29251724	A	45	-	24	8	3,3	1/2"x1"	48	1,57
2517	85,5	29251725	A	45	-	25	8	3,3	1/2"x1"	48	1,56
2517	85,5	29251728	A	45	-	28	8	3,3	1/2"x1"	48	1,52
2517	85,5	29251730	A	45	-	30	8	3,3	1/2"x1"	48	1,49
2517	85,5	29251732	A	45	-	32	10	3,3	1/2"x1"	48	1,45
2517	85,5	29251733	A	45	-	33	10	3,3	1/2"x1"	48	1,40
2517	85,5	29251735	A	45	-	35	10	3,3	1/2"x1"	48	1,40
2517	85,5	29251738	A	45	-	38	10	3,3	1/2"x1"	48	1,40
2517	85,5	29251740	A	45	-	40	12	3,3	1/2"x1"	48	1,35
2517	85,5	29251742	A	45	-	42	12	3,3	1/2"x1"	48	1,27
2517	85,5	29251745	A	45	-	45	14	3,8	1/2"x1"	48	1,20
2517	85,5	29251748	A	45	-	48	14	3,8	1/2"x1"	48	1,13
2517	85,5	29251750	A	45	-	50	14	3,8	1/2"x1"	48	1,08
2517	85,5	29251755	A	45	-	55	16	4,3	1/2"x1"	48	0,96
2517	85,5	29251760	A	45	-	60	18	4,4	1/2"x1"	48	0,81
2517	85,5	29251765	A	45	-	65	18	4,4	1/2"x1"	48	0,65

 MATERIAL **GREY CAST IRON**  
 norm **UNI EN 1561**

 Bushes with prebore  
 without keyway

 CAD drawings available on our site  
[www.chiaravalli.com](http://www.chiaravalli.com)

 Quantity, availability and prices  
 on B2B Chiaravalli



**METRIC SERIES**

Reamings in mm. **ISO G7**

Keyway in compliance with **DIN 6885-JS9**

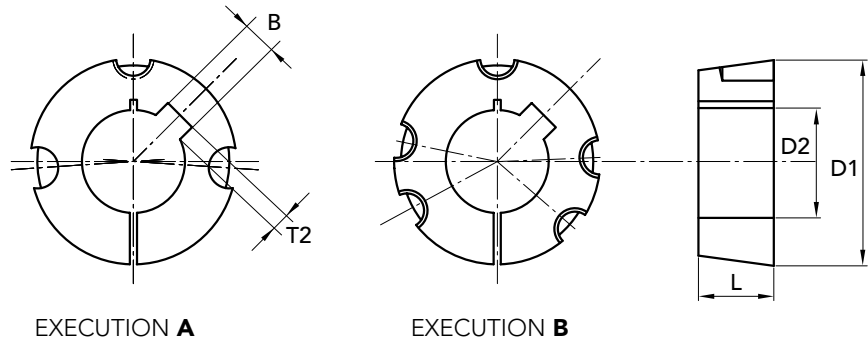

EXECUTION A

EXECUTION B

BUSHES TYPE	Ø D1	PART NUMBER	execution	L	Ø D2 H8 only prebore	Ø D2 with bore ISO G7 keyway DIN 6885-JS9	B keyway width	T2 keyway depth	GRUBSCREW British Standard Whitworth	tightening torque N/m	weight Kg
3020	108	29302000	A	51	20	-	-	-	5/8"x1" 1/4	90	2,79
3020	108	29302020	A	51	-	20	6	2,8	5/8"x1" 1/4	90	2,79
3020	108	29302028	A	51	-	28	8	3,3	5/8"x1" 1/4	90	2,79
3020	108	29302030	A	51	-	30	8	3,3	5/8"x1" 1/4	90	2,84
3020	108	29302032	A	51	-	32	10	3,3	5/8"x1" 1/4	90	2,80
3020	108	29302035	A	51	-	35	10	3,3	5/8"x1" 1/4	90	2,75
3020	108	29302038	A	51	-	38	10	3,3	5/8"x1" 1/4	90	2,67
3020	108	29302040	A	51	-	40	12	3,3	5/8"x1" 1/4	90	2,64
3020	108	29302042	A	51	-	42	12	3,3	5/8"x1" 1/4	90	2,59
3020	108	29302045	A	51	-	45	14	3,8	5/8"x1" 1/4	90	2,52
3020	108	29302048	A	51	-	48	14	3,8	5/8"x1" 1/4	90	2,43
3020	108	29302050	A	51	-	50	14	3,8	5/8"x1" 1/4	90	2,37
3020	108	29302055	A	51	-	55	16	4,3	5/8"x1" 1/4	90	2,23
3020	108	29302060	A	51	-	60	18	4,4	5/8"x1" 1/4	90	2,07
3020	108	29302065	A	51	-	65	18	4,4	5/8"x1" 1/4	90	1,89
3020	108	29302070	A	51	-	70	20	4,9	5/8"x1" 1/4	90	1,69
3020	108	29302075	A	51	-	75	20	4,9	5/8"x1" 1/4	90	1,49
3030	108	29303000	A	76	30	-	-	-	5/8"x1" 1/4	90	3,95
3030	108	29303030	A	76	-	30	8	3,3	5/8"x1" 1/4	90	3,95
3030	108	29303035	A	76	-	35	10	3,3	5/8"x1" 1/4	90	3,95
3030	108	29303038	A	76	-	38	10	3,3	5/8"x1" 1/4	90	3,86
3030	108	29303042	A	76	-	42	12	3,3	5/8"x1" 1/4	90	3,69
3030	108	29303045	A	76	-	45	14	3,8	5/8"x1" 1/4	90	3,55
3030	108	29303048	A	76	-	48	14	3,8	5/8"x1" 1/4	90	3,45
3030	108	29303050	A	76	-	50	14	3,8	5/8"x1" 1/4	90	3,42
3030	108	29303055	A	76	-	55	16	4,3	5/8"x1" 1/4	90	3,18
3030	108	29303060	A	76	-	60	18	4,4	5/8"x1" 1/4	90	2,95
3030	108	29303065	A	76	-	65	18	4,4	5/8"x1" 1/4	90	2,68
3030	108	29303070	A	76	-	70	20	4,9	5/8"x1" 1/4	90	2,38
3030	108	29303075	A	76	-	75	20	4,9	5/8"x1" 1/4	90	2,03

MATERIAL **GREY CAST IRON**  
norm UNI EN 1561

Bushes with prebore  
without keway

CAD drawings available on our site  
[www.chiaravalli.com](http://www.chiaravalli.com)

Quantity, availability and prices  
on B2B Chiaravalli



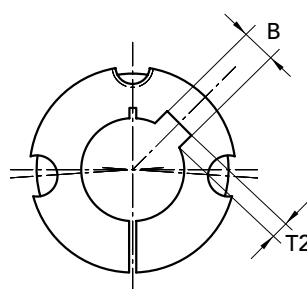

**METRIC SERIES**

 Reamings in mm. **ISO G7**

 Keyway in compliance with **DIN 6885-JS9**

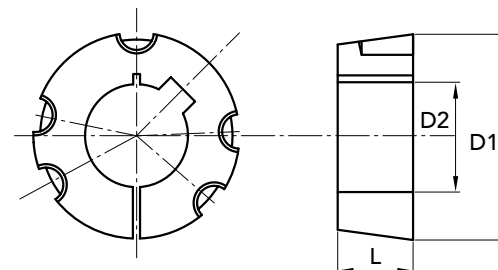
EXECUTION A



EXECUTION B

BUSHES TYPE	Ø D1	PART NUMBER	execution	L	Ø D2 H8 only prebore	Ø D2 with bore ISO G7 keyway DIN 6885-JS9	B keyway width	T2 keyway depth	GRUBSCREW British Standard Whitworth	tightening torque N/m	weight Kg
3525	127	29352500	B	65	30	-	-	-	1/2"x1" 1/2	113	4,85
3525	127	29352530	B	65	-	30	8	3,3	1/2"x1" 1/2	113	4,85
3525	127	29352538	B	65	-	38	10	3,3	1/2"x1" 1/2	113	4,85
3525	127	29352540	B	65	-	40	12	3,3	1/2"x1" 1/2	113	4,80
3525	127	29352542	B	65	-	42	12	3,3	1/2"x1" 1/2	113	4,71
3525	127	29352545	B	65	-	45	14	3,8	1/2"x1" 1/2	113	4,67
3525	127	29352548	B	65	-	48	14	3,8	1/2"x1" 1/2	113	4,55
3525	127	29352550	B	65	-	50	14	3,8	1/2"x1" 1/2	113	4,44
3525	127	29352555	B	65	-	55	16	4,3	1/2"x1" 1/2	113	4,29
3525	127	29352560	B	65	-	60	18	4,4	1/2"x1" 1/2	113	4,05
3525	127	29352565	B	65	-	65	18	4,4	1/2"x1" 1/2	113	3,88
3525	127	29352570	B	65	-	70	20	4,9	1/2"x1" 1/2	113	3,58
3525	127	29352575	B	65	-	75	20	4,9	1/2"x1" 1/2	113	3,37
3525	127	29352580	B	65	-	80	22	5,4	1/2"x1" 1/2	113	3,05
3525	127	29352585	B	65	-	85	22	5,4	1/2"x1" 1/2	113	3,05
3525	127	29352590	B	65	-	90	25	5,4	1/2"x1" 1/2	113	3,05
3535	127	29353500	B	89	30	-	-	-	1/2"x1" 1/2	113	6,48
3535	127	29353530	B	89	-	30	8	3,3	1/2"x1" 1/2	113	6,48
3535	127	29353535	B	89	-	35	10	3,3	1/2"x1" 1/2	113	6,40
3535	127	29353540	B	89	-	40	12	3,3	1/2"x1" 1/2	113	6,48
3535	127	29353542	B	89	-	42	12	3,3	1/2"x1" 1/2	113	6,40
3535	127	29353545	B	89	-	45	14	3,8	1/2"x1" 1/2	113	6,25
3535	127	29353548	B	89	-	48	14	3,8	1/2"x1" 1/2	113	6,17
3535	127	29353550	B	89	-	50	14	3,8	1/2"x1" 1/2	113	6,05
3535	127	29353555	B	89	-	55	16	4,3	1/2"x1" 1/2	113	5,81
3535	127	29353560	B	89	-	60	18	4,4	1/2"x1" 1/2	113	5,50
3535	127	29353565	B	89	-	65	18	4,4	1/2"x1" 1/2	113	5,20
3535	127	29353570	B	89	-	70	20	4,9	1/2"x1" 1/2	113	4,88
3535	127	29353575	B	89	-	75	20	4,9	1/2"x1" 1/2	113	4,46
3535	127	29353580	B	89	-	80	22	5,4	1/2"x1" 1/2	113	4,08
3535	127	29353585	B	89	-	85	22	5,4	1/2"x1" 1/2	113	3,67
3535	127	29353590	B	89	-	90	25	5,4	1/2"x1" 1/2	113	3,21

**MATERIAL GREY CAST IRON**  
**norm UNI EN 1561**

 Bushes with prebore  
 without keyway

 CAD drawings available on our site  
[www.chiaravalli.com](http://www.chiaravalli.com)

 Quantity, availability and prices  
 on B2B Chiaravalli







**METRIC SERIES**

Reamings in mm. **ISO G7**

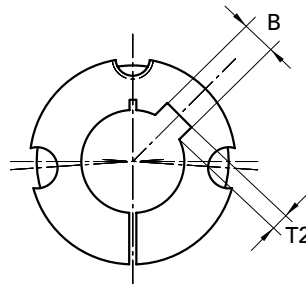
Keyway in compliance with **DIN 6885-JS9**

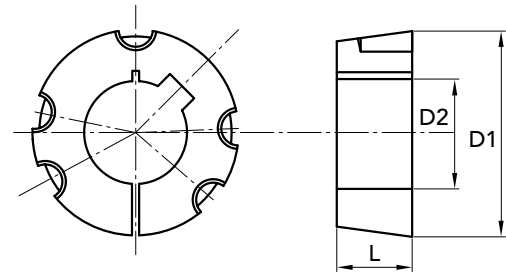

EXECUTION A



EXECUTION B

BUSHES TYPE	Ø D1	PART NUMBER	execution	L	Ø D2 H8 only prebore	Ø D2 with bore ISO G7 keyway DIN 6885-JS9	B keyway width	T2 keyway depth	GRUBSCREW British Standard Whitworth	tightening torque N/m	weight Kg
4030	146	29403000	B	76	30	-	-	-	5/8"x1" 3/4	169	6,65
4030	146	29403030	B	76	-	30	8	3,3	5/8"x1" 3/4	169	6,65
4030	146	29403040	B	76	-	40	12	3,3	5/8"x1" 3/4	169	6,75
4030	146	29403042	B	76	-	42	12	3,3	5/8"x1" 3/4	169	6,65
4030	146	29403045	B	76	-	45	14	3,8	5/8"x1" 3/4	169	6,58
4030	146	29403048	B	76	-	48	14	3,8	5/8"x1" 3/4	169	6,55
4030	146	29403050	B	76	-	50	14	3,8	5/8"x1" 3/4	169	6,40
4030	146	29403055	B	76	-	55	16	4,3	5/8"x1" 3/4	169	6,40
4030	146	29403060	B	76	-	60	18	4,4	5/8"x1" 3/4	169	6,35
4030	146	29403065	B	76	-	65	18	4,4	5/8"x1" 3/4	169	6,35
4030	146	29403070	B	76	-	70	20	4,9	5/8"x1" 3/4	169	6,30
4030	146	29403075	B	76	-	75	20	4,9	5/8"x1" 3/4	169	6,30
4030	146	29403080	B	76	-	80	22	5,4	5/8"x1" 3/4	169	6,10
4030	146	29403085	B	76	-	85	22	5,4	5/8"x1" 3/4	169	6,10
4030	146	29403090	B	76	-	90	25	5,4	5/8"x1" 3/4	169	5,90
4040	146	29404000	B	102	35	-	-	-	5/8"x 1" 3/4	169	9,48
4040	146	29404035	B	102	-	35	10	3,3	5/8"x 1" 3/4	169	9,48
4040	146	29404050	B	102	-	50	14	3,8	5/8"x 1" 3/4	169	9,48
4040	146	29404055	B	102	-	55	16	4,3	5/8"x 1" 3/4	169	9,27
4040	146	29404060	B	102	-	60	18	4,4	5/8"x 1" 3/4	169	8,93
4040	146	29404065	B	102	-	65	18	4,4	5/8"x 1" 3/4	169	8,65
4040	146	29404070	B	102	-	70	20	4,9	5/8"x 1" 3/4	169	8,17
4040	146	29404075	B	102	-	75	20	4,9	5/8"x 1" 3/4	169	7,78
4040	146	29404080	B	102	-	80	22	5,4	5/8"x 1" 3/4	169	7,35
4040	146	29404085	B	102	-	85	22	5,4	5/8"x 1" 3/4	169	6,89
4040	146	29404090	B	102	-	90	25	5,4	5/8"x 1" 3/4	169	6,36
4040	146	29404095	B	102	-	95	25	5,4	5/8"x 1" 3/4	169	5,94
4535	162	29453500	B	89	35	-	-	-	3/4"x2"	192	10,70
4535	162	29453535	B	89	-	35	10	3,3	3/4"x2"	192	10,70
4535	162	29453565	B	89	-	65	18	4,4	3/4"x2"	192	10,50
4535	162	29453570	B	89	-	70	20	4,9	3/4"x2"	192	10,20
4535	162	29453575	B	89	-	75	20	4,9	3/4"x2"	192	9,95
4535	162	29453580	B	89	-	80	22	5,4	3/4"x2"	192	9,95
4535	162	29453585	B	89	-	85	22	5,4	3/4"x2"	192	9,90
4535	162	29453590	B	89	-	90	25	5,4	3/4"x2"	192	9,80
4535	162	29453595	B	89	-	95	25	5,4	3/4"x2"	192	9,75
4535	162	29453599	B	89	-	100	28	6,4	3/4"x2"	192	9,65
4535	162	29453110	B	89	-	110	28	6,4	3/4"x2"	192	9,55
4535	162	29453120	B	89	-	120	32	7,4	3/4"x2"	192	9,45

MATERIAL **GREY CAST IRON**  
norm UNI EN 1561

Bushes with prebore  
without keway

CAD drawings available on our site  
[www.chiaravalli.com](http://www.chiaravalli.com)

Quantity, availability and prices  
on B2B Chiaravalli



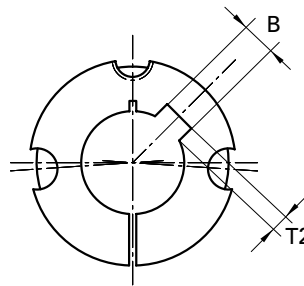

**METRIC SERIES**

 Reamings in mm. **ISO G7**

 Keyway in compliance with **DIN 6885-JS9**

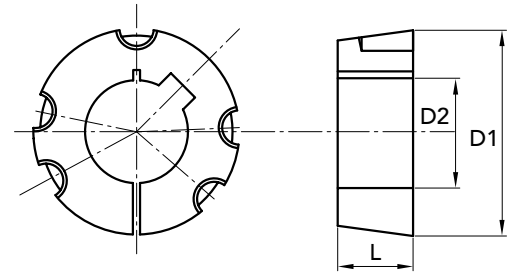
EXECUTION A



EXECUTION B

BUSHES TYPE	Ø D1	PART NUMBER	execution	L	Ø D2 H8 only prebore	Ø D2 with bore ISO G7 keyway DIN 6885-JS9	B keyway width	T2 keyway depth	GRUBSCREW British Standard Whitworth	tightening torque N/m	weight Kg
4545	162	29454500	B	115	35	-	-	-	3/4"x2"	192	13,15
4545	162	29454535	B	115	-	35	10	3,3	3/4"x2"	192	13,15
4545	162	29454555	B	115	-	55	16	4,3	3/4"x2"	192	13,15
4545	162	29454560	B	115	-	60	18	4,4	3/4"x2"	192	12,76
4545	162	29454565	B	115	-	65	18	4,4	3/4"x2"	192	12,38
4545	162	29454570	B	115	-	70	20	4,9	3/4"x2"	192	12,02
4545	162	29454575	B	115	-	75	20	4,9	3/4"x2"	192	11,57
4545	162	29454580	B	115	-	80	22	5,4	3/4"x2"	192	11,05
4545	162	29454585	B	115	-	85	22	5,4	3/4"x2"	192	10,46
4545	162	29454590	B	115	-	90	25	5,4	3/4"x2"	192	9,99
4545	162	29454595	B	115	-	95	25	5,4	3/4"x2"	192	9,42
4545	162	29454599	B	115	-	100	28	6,4	3/4"x2"	192	8,63
4545	162	29454610	B	115	-	110	28	6,4	3/4"x2"	192	7,37
5040	177,6	29504000	B	102	50	-	-	-	7/8"x2" 1/4	272	12,20
5040	177,6	29504050	B	102	-	50	14	3,8	7/8"x2" 1/4	272	12,20
5040	177,6	29504070	B	102	-	70	20	4,9	7/8"x2" 1/4	272	11,90
5040	177,6	29504075	B	102	-	75	20	4,9	7/8"x2" 1/4	272	11,90
5040	177,6	29504080	B	102	-	80	22	5,4	7/8"x2" 1/4	272	11,30
5040	177,6	29504085	B	102	-	85	22	5,4	7/8"x2" 1/4	272	11,30
5040	177,6	29504090	B	102	-	90	25	5,4	7/8"x2" 1/4	272	10,60
5040	177,6	29504099	B	102	-	100	28	6,4	7/8"x2" 1/4	272	10,60
5040	177,6	29504110	B	102	-	110	28	6,4	7/8"x2" 1/4	272	10,00
5040	177,6	29504120	B	102	-	120	32	7,4	7/8"x2" 1/4	272	9,70
5040	177,6	29504125	B	102	-	125	32	7,4	7/8"x2" 1/4	272	9,70
5050	177,6	29505000	B	127	50	-	-	-	7/8"x2" 1/4	272	16,70
5050	177,6	29505050	B	127	-	50	14	3,8	7/8"x2" 1/4	272	16,70
5050	177,6	29505065	B	127	-	65	18	4,4	7/8"x2" 1/4	272	16,70
5050	177,6	29505070	B	127	-	70	20	4,9	7/8"x2" 1/4	272	16,70
5050	177,6	29505075	B	127	-	75	20	4,9	7/8"x2" 1/4	272	16,05
5050	177,6	29505080	B	127	-	80	22	5,4	7/8"x2" 1/4	272	15,56
5050	177,6	29505085	B	127	-	85	22	5,4	7/8"x2" 1/4	272	15,00
5050	177,6	29505090	B	127	-	90	25	5,4	7/8"x2" 1/4	272	14,43
5050	177,6	29505095	B	127	-	95	25	5,4	7/8"x2" 1/4	272	13,88
5050	177,6	29505099	B	127	-	100	28	6,4	7/8"x2" 1/4	272	13,05
5050	177,6	29505110	B	127	-	110	28	6,4	7/8"x2" 1/4	272	11,56
5050	177,6	29505115	B	127	-	115	32	7,4	7/8"x2" 1/4	272	15,17
5050	177,6	29505120	B	127	-	120	32	7,4	7/8"x2" 1/4	272	9,78
5050	177,6	29505125	B	127	-	125	32	7,4	7/8"x2" 1/4	272	9,05

**MATERIAL GREY CAST IRON**  
 norm UNI EN 1561

 Bushes with prebore  
 without keyway

 CAD drawings available on our site  
[www.chiaravalli.com](http://www.chiaravalli.com)

 Quantity, availability and prices  
 on B2B Chiaravalli

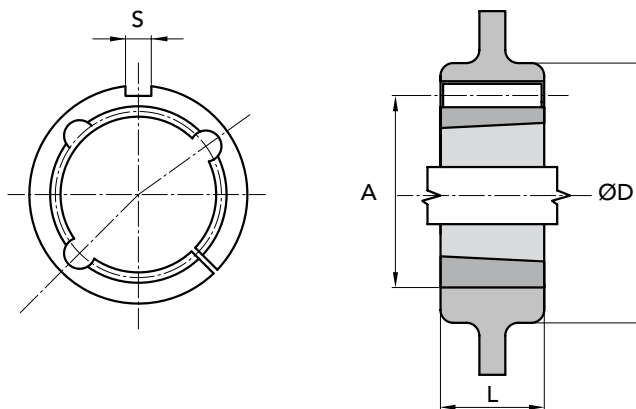
TYPE ADAPTORS	PART NUMBER	N. TAPER BUSHE	L	A	Ø D FOR HUBS of PULLEYS and SPROCKETS in CAST IRON and		S	WEIGHT Kg. for C.I.
					CAST IRON	STEEL		
ARC 1008	29901008	1008	22	45	75	60	5 x 5	0,45
ARC 1210	29901210	1210	25	60	105	85	6 x 6	0,70
ARC 1610	29901610	1610	25	70	115	95	10 x 8	0,80
ARC 1615	29901615	1615	38	70	115	95	10 x 8	0,90
ARC 2517	29902517	2517	45	105	150	130	16 x 10	2,20
ARC 3030	29903030	3030	76	130	190	160	20 x 12	5,80
ARC 3535	29903535	3535	90	160	240	200	22 x 12	11,30
ARC 4040	29904040	4040	102	185	290	240	24 x 12	17,30

MATERIAL **GREY CAST IRON**  
norm UNI EN 1561

CAD drawings available on our site  
[www.chiaravalli.com](http://www.chiaravalli.com)

Quantity, availability and prices  
on B2B Chiaravalli





# LOGISTIC

# CENTER

# CANTALUPA

*The Chiaravalli Group, always aware of the needs of the market has found it necessary to provide its long-standing customers with complete, steady up-dated information about its products*

*24 hours a day  
365 days in a year.*

*The Chiaravalli logistic group has established itself over the years becoming an example of excellence for all the European companies working in the same sector.*

